

명품양돈의 시작

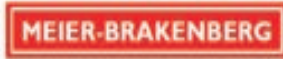

Catalogue 2026~2027



홈페이지 방문



카카오톡 상담

축산·양돈기자재 전문기업
BAROTECH (주)바로텍

Greeting

새롭게 거듭 나겠습니다!

(주)바로텍은 양돈시설 및 축산기자재 전문기업으로 20여년간 쌓아온 경험과 기술력을 바탕으로 생산성과 내구성을 두루 갖춘 최고의 제품만을 엄선하여 합리적인 가격, 철저한 품질관리, 신속한 납품, 완벽한 시공을 신념으로 고객 만족을 위한, 양질의 서비스와 축산 농가의 발전을 위해 최선을 다하겠습니다.



양돈인의 입장에서 생각하며 양돈인을 위한 최고의 제품만을 공급하겠습니다.



(주)바로텍 임직원일동

Index

바닥재/칸막이(04-17)

플라스틱배드  (독일)	04
플라스틱배드(Local)	07
주철배드  (독일)	08
바닥재   (네덜란드)	09
스텐 트라이바  (네덜란드)	10
델타빔  (중국)	11
바닥재 고정부품	12
임신스톨/분만케이지	13
칸막이(PP)  (스페인)	15
칸막이(PVC)   (중국)	16
거푸집(PVC)	17

사료자동라인(18-25)

구동부/호퍼/코너  (이탈리아)	18
사료자동라인(Local)	19
계량통  (독일)	21
사료자동라인 부자재	22
사각양면급이기  (독일)	24
급이기(Local)	25





워터컵/니플/급수자재(27-34)

동물복지사양기구  (독일)	27
 (네덜란드)	
워터컵   (독일)	28
음수투약기  (이탈리아)	29
 (프랑스)	
자동급수기/스윙워터컵  (스페인)	30
급수배관자재	31
니플   (독일)	34
 (스웨덴)	

환기/난방(35-42)

벽면환/릴레이환	35
피트환/굴뚝환/후드	36
대형환   (이탈리아/스웨덴)	37
입기창/웬컨트롤러	38
쿨링패드  (독일)	39
보온패드/커버  (스페인)	40
보온커버  (중국)	40
보온매트/보온갓/전구	41
보온전구/소켓/원치	42

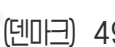
사양기구(43-51)

돈형기  (독일)	43
사체운반기  (독일)	45
트랜스포커/스피디  (독일)	46
단미기/마커/스프레이/슬러리볼	47
문신기/니퍼/크린매트	48
대용유/자동급이시스템  (덴마크)	49
사체운반기  (독일)	50
돈분제거기/소독기/세척기	50
세척기건/배합기/방화도어	51









Global Partners(52)

독점공급업체 소개(53)

토목/건축(62)

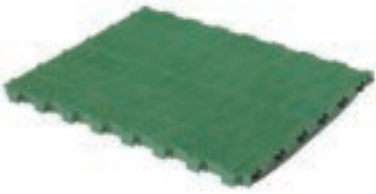

01	CHESS	02	CHESS G10%	03	CHESS GR
					
<p>자돈용 / 독일 MIK사 600mmx600mm OPEN 39% 하중 : 90kg</p>		<p>자돈용 / 독일 MIK사 600mmx600mm OPEN 10% 하중 : 90kg</p>		<p>자돈용 / 독일 MIK사 600mmx600mm OPEN 0% 하중 : 90kg</p>	
04	RUBIN	05	RUBIN	06	RUBIN G
					
<p>자돈용 / 독일 MIK사 400mmx600mm 하중 : 110kg</p>		<p>자돈용 / 독일 MIK사 500mmx600mm 하중 : 110kg</p>		<p>자돈용 / 독일 MIK사 400mmx600mm 하중 : 110kg</p>	
07	RUBIN GR	08	TRAPPER XL	09	분뇨배출구
					
<p>육성용 / 독일 MIK사 400mmx600mm 하중 : 110kg</p>		<p>비육용 / 독일 MIK사 800mmx600mm 하중 : 200kg</p>		<p>독일 MIK사 130mmx380mm 하중 : 110kg</p>	

10	SWING	11	SWING	12	SWING
					
<p>모든용 / 독일 MIK사 400mmx600mm 하중 : 350kg</p>		<p>모든용 / 독일 MIK사 500mmx600mm 하중 : 350kg</p>		<p>모든용 / 독일 MIK사 400mmx100mm 하중 : 350kg</p>	
13	SWING	14	SWING	15	TITAN GR
					
<p>모든용 / 독일 MIK사 500mmx100mm 하중 : 350kg</p>		<p>모든용 / 독일 MIK사 600mmx100mm 하중 : 350kg</p>		<p>모든용 / 독일 MIK사 600mmx800mm 100% 하중 : 350kg</p>	
16	SWING G	17	SWING G 5%	18	SWING TITAN
					
<p>모든용 / 독일 MIK사 400mmx600mm 99.3% 하중 : 350kg</p>		<p>모든용 / 독일 MIK사 400mmx600mm 95% 하중 : 350kg</p>		<p>모든용 / 독일 MIK사 600mmx800mm 하중 : 350kg</p>	



01	플라스틱 배드	02	플라스틱 배드	03	플라스틱 배드
					
<p>하나로 I 400mmx600mm</p>		<p>하나로 II 400mmx300mm</p>		<p>하나로 III / 유두보호, 자동잡자리용 400mmx300mm</p>	
04	플라스틱 배드	05	플라스틱 배드	06	플라스틱 배드
					
<p>자동용 600mmx600mm</p>		<p>자동용 400mmx600mm</p>		<p>모든용 300mmx400mm</p>	
07	플라스틱 배드	08	플라스틱 배드	09	플라스틱 배드
					
<p>자동용 600mmx600mm</p>		<p>모든용 300mmx400mm 홀</p>		<p>모든용 400mmx1,200mm</p>	

01

주철배드(독일 Schonlau)

12년 전통 주철배드의 원조!

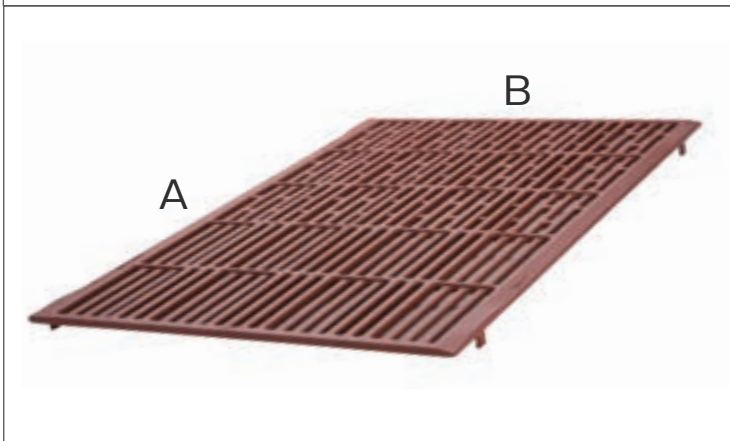

15mm고상배드 (AB결합형)

- **사이즈** : 600mmx600mm
600mmx1,000mm
- **무게** : 54kg
- 유두보호 / 미끄럼방지
- 지제사고 예방에 탁월

01

바닥재(네덜란드 NOOYEN)

동물복지 바닥재의 정석!

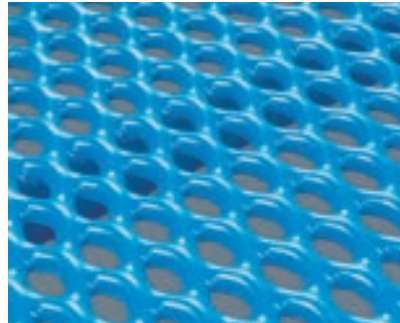

동물복지 바닥재 / 네덜란드 NOOYEN

자돈사/육성사/비육사/분만사(대각형, 일반형) 주문제작

- 부드러운 플라스틱(Plasticsol코팅)
- 자돈의 스트레스 최소화
- 모돈의 유두 보호
- 라운딩 마감 처리로 수세시간 대폭 단축
- 위생적인 구조로 질병예방 탁월
- 별도의 보강기둥 및 델타빔 필요없음

01

스텐트라이바

설치간편 / 주문제작 가능



스텐 트라이바 / 네덜란드 REENDERS ROOSTERS

·반영구적 사용 ·분뇨배출 탁월 ·수세 용이 ·미끄럼 방지

01

고강도 델타빔

3겹 유리섬유 보강으로
휨이나 뒤틀림없는 강한 구조



델타빔

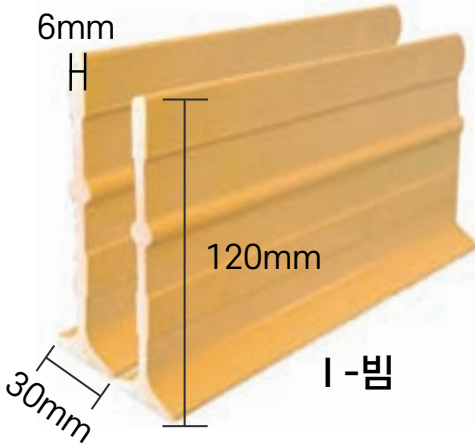

I-빔

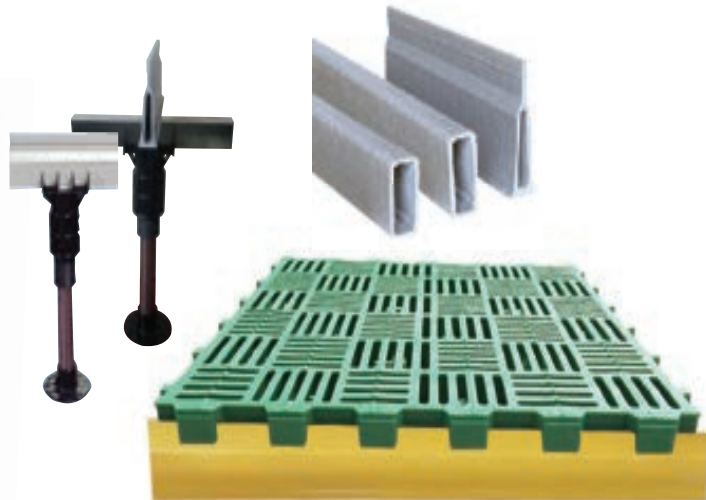

델타빔 / I-빔(아이빔)

- 밀면 폭 : 36mm
- 바닥판 끼움부 : 6mmx15mm
- 색상 : 회색(Gray)
- 압축가능 : 3,300/kgf/cm²
- 높이 : 120mm
- 중량 : 1.73kg/M
- 재질 : 수지강화플라스틱 (FRP)
- 휨 강도 : 3100kgf/cm²
- 길이 : 주문생산 가능

01	자동고리	02	자동고리	03	힌지너트
					
<p>임신스틀 뒷문용 스텐 304</p>		<p>스텐 304 / 아연</p>		<p>콘슬랏용 폭 100mm / M8, M10</p>	
04	힌지너트	05	T-볼트	06	S자 고리
					
<p>플라스틱 베드용 / M8</p>		<p>콘슬랏용/120/150/160mm</p>		<p>90/100/110/120/130/140/150/160mm 170mm 이상 주문 제작</p>	
07	7자볼트 / J볼트	08	콘슬랏 마개	09	클릭인(Click -In)
<p>7자볼트</p>  <p>J볼트/후크볼트</p>		  		  	
<p>7자볼트(델타빔용):M9/180mm J볼트(평철용):100/140/165/185/200mm</p>		<p>길이:2.5M / 두께:18~22mm</p>		<p>490mmx38mm</p>	

01

임신스톨

견고한 프레임 / 전체 용융도금 처리
KS 파이프 사용 / 100% 조립형
길이 2,150mm x 높이 1,090mm

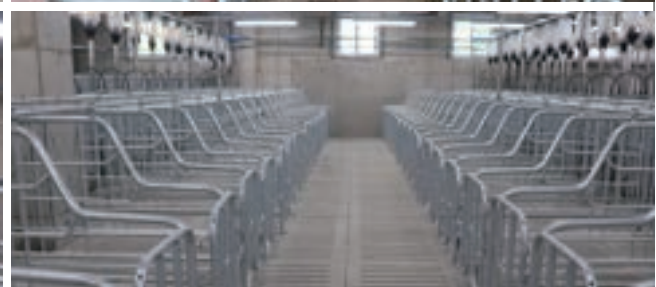

01

PP 칸막이(Rotecna)

뛰어난 내구성/설치 편리성



·VENT(뚫린 타입)

·CLOSE(막힌 타입)



- VENT(뚫린 타입) : 가로 1,200mm x 높이 1,000mm x 두께 50T / 흑색
- CLOSE(막힌 타입) : 가로 1,200mm x 높이 1,000mm x 두께 50T / 흑색

01

**PVC 칸막이
(KUNLONG/MIK)**

다양한 규격으로 폭넓은 선택가능
산.염기성 및 소독제에 강함
그рей/화이트 및 기타 색상 주문가능



모 델	높이(H)	두께(T)	비 고
P - 50	500	35	조립형
P - 505	500	50	민자형
P - 60	600	35	민자형
P - 75	750	35	민자형
P-100	1,000	35	민자형

01

PVC 거푸집

경량 / 비, 습기에 강함 / 취급.관리 용이



PVC 거푸집(500w x 120t)



PVC 거푸집



PVC 거푸집



합성수지 지붕재



PVC 중천장 패널(단면)
500w x 22t



PVC 중천장 패널

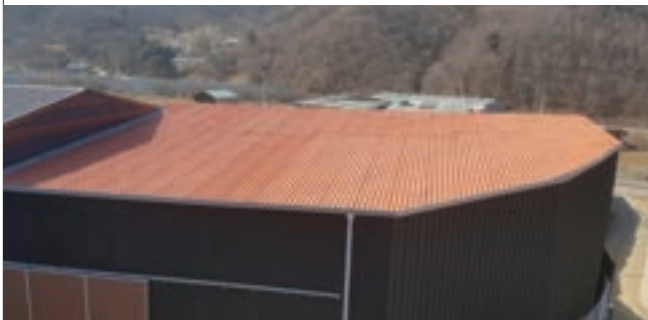

01	구동부	02	플라스틱 코너	03	알루미늄 코너
					
이탈리아 팔콘 AN602 HP2/60Ø		이탈리아 팔콘 60Ø / 102Ø / 90°		이탈리아 팔콘 60Ø / 102Ø / 90°	
04	알루미늄 코너	05	알루미늄 코너	06	체인 디스크
					
이탈리아 팔콘 60Ø / 102Ø / 135°		이탈리아 팔콘 60Ø / 102Ø / 360°		이탈리아 팔콘 60Ø / 43mm / 피치 70mm	



01	구동부	02	가이드로라	03	가이드로라 세트
					
<p>마찰식 디스크 회전방식 => 소음 최소화 60:1의 감속기 적용 / 2중 안전 장치 AN60 220V,380V,420,480,600</p>		<p>외경 : 205mm</p>		<p>가이드로라+평철+와이어</p>	
04	구동부 감속기	05	구동부 모터	06	스프라켓(톱니형)
		<p>단상</p>  <p>삼상</p> 			
<p>비율 30:1 / 80평형</p>		<p>단상 : 1.5HP 삼상 : 2.0HP</p>		<p>플리직경 : 32mm 피치 : 50mm 외경 : 275mm</p>	
07	플라스틱 코너	08	플라스틱 코너	09	플라스틱 코너
					
<p>투명 / 480 / 90°</p>		<p>회색 / 480 / 90°</p>		<p>420 / 480 / 90°</p>	

10	알루미늄 코너	11	알루미늄 코너	12	스텐 코너
					
회색 / 42Ø / 48Ø / 90°		흰색 / 42Ø / 48Ø / 90°		48Ø / 60Ø / 90°	
13	자동라인 컨트롤러	14	자동라인 컨트롤러	15	디스크 케이블
					
단상/타이머 유무선택 가능		삼상/타이머 유무선택 가능		42Ø / 48Ø / 60Ø	
16	체인 디스크	17	디스크 커플링	18	슈트캡/슈트파이프 세트
					
이탈리아 팔콘 60Ø / 43mm / 피치 70mm		5.5mm / 7.5mm		겉대+속대+반도 42Ø / 48Ø / 60Ø	

19

계량통(MIK)

정확한 사료량 조절 . 스텐 재질 조절판
75mm의 넉넉한 배출구 . 하부 개폐 가능
투명으로 사용 잔량 여부 확인 가능



개폐가능
배출구 변경가능



원터치 투명 OUTLET



20	계량통	21	계량통	22	스텐 호퍼
					
<p>임신사/분만사용(42Ø/48Ø) 3kg / 5.8kg</p>		<p>임신사/분만사용(42Ø/48Ø) 2.6kg / 3.8kg / 5.4kg</p>		<p>무동력 오거방식 : 브릿지현상 방지</p>	
23	삼각호퍼	24	근접센서	25	사각리미트센서
					
<p>아연/스텐, 쌍호퍼/외호퍼 42Ø / 48Ø / 60Ø</p>		<p>CUP 18RP-8FC/ACE타입/청색</p>		<p>100mmx190mm</p>	
26	구동부 센서	27	완충고무.부싱	28	레바대 세트
		 <p>주름형</p>			
<p>리미트 스위치</p>		<p>주름형 / 일반형 / 48Ø / 60Ø</p>		<p>레바대+스프링+클립+티클립 +도르레+볼트.너트+브라켓</p>	

29	사료토출구	30	파이프커플링	31	티클립(T-클램프)
					
105Ø		스텐 42Ø / 48Ø / 60Ø		42Ø / 48Ø / 60Ø	
32	압착기	33	라인행거	34	슈트파이프 깔때기세트
					
전장 : 62cm		양계용 25cm / PVC		84-140cm까지 높낮이 조절가능	
35	공파이프(스텐)	36	공파이프(아연)	37	오버관
					
42Ø / 48Ø / 60Ø 길이 : 6M		42Ø / 48Ø / 60Ø 길이 : 6M		48Ø / 60Ø 겸용	

01

사각양면급이기(MIK)

최적의 가성비 / 사료 허실 최소화



01	10구원형이유자돈급이기	02	7구원형건식급이기	03	10구대형급이기
 <p>1,000 500</p>		 <p>760 650</p>		 <p>1,250 1,000</p>	
<p>이유자돈용 25-35kg / 건식, 습식 500mmx1,000mm / 허실 방지턱 부착</p>		<p>자돈용 / 건식 610mmx780mm</p>		<p>육성, 비육용 / 건식, 습식 1,000mmx1,250mm</p>	
04	2구원형급이기	05	4구원형급이기	06	사각양면급이기(습식)
 <p>1,200 450</p>		 <p>1,340 170 585</p>		 <p>자돈, 육성, 비육 570, 600, 700</p>	
<p>비육용 / 습식 450mmx1,200mm</p>		<p>육성, 비육용 / 습식 585x1,340x170mm</p>		<p>자돈: (H)1,200x(W)570 육성: (H)1,300x(W)600 비육: (H)1,400x(W)700</p>	
07	부자급이기				
 <p>이유초기, 자돈용, 육성용, 육성비육용, 비육용, 특(대)</p> <p>530, 620, 620, 620, 730, 830</p>					
<p>이유초기/자돈/육성/육성비육/비육/특 직경 : 530/620/620/620/730/830mm</p>					

08	스텐모돈급이기(투구형)	09	스텐모돈급이기(광폭)	10	플라스틱모돈급이기	11	플라스틱모돈급이기
24종/27종 스텐 1.5t 340x430/380x500mm		사각 530x390x230mm		소형:340x430x180mm 대형:360x460x180mm		파랑 360mmx450mm	

12	스텐액상맘마급이기	13	스텐맘마급이기	14	이유자돈급이기
모노플로(Monoflo사) 240Øx189mmx40mm		포유자돈용 / 회전식 / 고정식 250Øx280mmx60mm		이유자돈용 / 10구 소:350Ø,2L / 대:500Ø,4L	

15	플라스틱맘마급이기	16	이유자돈입질급이기	17	플라스틱액상급이기
295Øx260x60mm / 3.5L 우수한 내구성(PP재질)/사료허실 방지(6cm) 간편하고 편리한 급이기 고정		이유~15kg/10~15두용 / 클립조절형 430Øx700x85mm / 최대 26L 강한 내구성/섬세한 조절:사료허실없음		430Øx470x80mm / 5L/10구	

01

바이트 실린더



Bite Cylinder / 84 x 230mm

02

바이팅스타 내추럴



Biting Star Natural

03

바이팅링 내추럴



Biting Ring Natural / 80mm

04

바이팅볼 천연고무



Biting Ball Natural Rubber / 55, 75mm

05

바이팅볼 내추럴

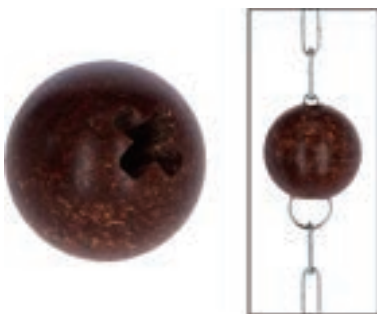

Biting Ball Natural / 75mm

06

이지픽스

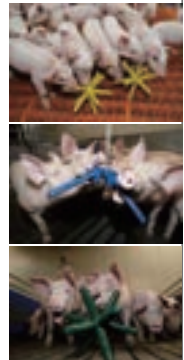
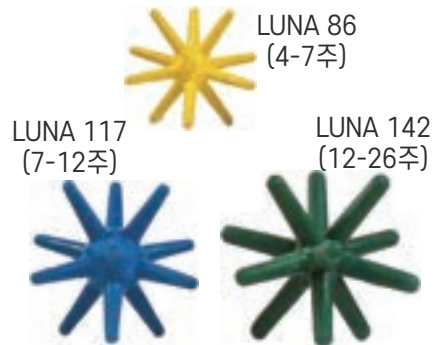

LUNA86:1~1.5kg / LUNA117:2.3kg / LUNA142:3kg전.후

01	스텐 단면워터컵	02	스텐 단면워터컵
			
<p>포유자돈용/~15kg용 W:110xH:124xD:72mm</p>		<p>이유자돈용/~35kg용 W:140xH:233xD:110mm</p>	
03	스텐 단면워터컵	04	스텐 단면워터컵
			
<p>비육용/~110kg W:202xH:309xD:145mm</p>		<p>모돈/웅돈용/150kg이상 W:227xH:350xD:203mm</p>	
05	플로팅 니플	06	수에비아 워터컵
			
<p>스웨덴 아쿠아볼니플 사용(AN-01,02) 탁월한 절수효과/풍부한 음수량/공간활용</p>		<p>포유자돈용/ ~15kg까지 W:100xH:160mm</p>	
07	수에비아 워터컵	08	수에비아 워터컵
			
<p>이유자돈용/35kg까지 W:170xH:200mm</p>		<p>비육용/20kg~출하 W:190xH:315mm</p>	
09	수에비아 워터컵		
<p>모든 임신 분만용 W:230xH:240mm</p>			

01 **믹스트론 음수투약기** 1개 시스템으로 모든 4,000두 공급

희석력 UP↑ **내구성 UP↑** **세척력 UP↑**

편리한 특수/간편세척 : 펌프분해X
1/4인치 수도 파이프 호스를 이용한 간편세척

탁월한 내구성
AISI 316 스테인레스 암수 나사 채택

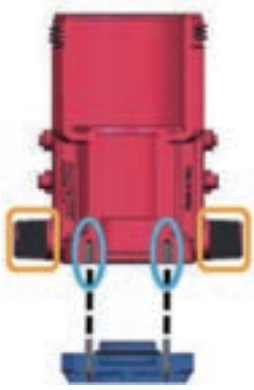

02 **도사트론 음수투약기**

보다 정밀한 희석능력 : 1,2차 혼합실을 통해 희석성능 우수

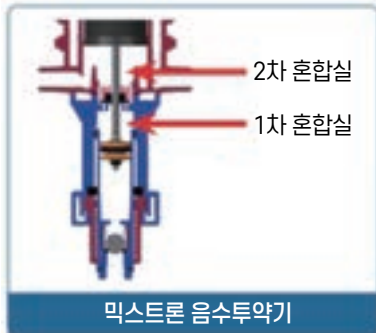

D25RE2 **B25BL2**

D25RE2 : 2~2.5 m³/h 0.2~2%
B25BL2 : 2~2.5 m³/h 0.2~2%

01	아쿠아자동급수기	02	아쿠아자동급수기(진공밸브형)	03	스윙워터컵
		<p>※초절수형</p>  <p>하단형 진공밸브</p> <p>14mm 환봉 보강</p>			
<p>스윙워터컵 / 자돈.비육 위생성 / 내구성(스텐레스 304)</p>		<p>위생성.내구성(스텐 304) 하단형 진공밸브 / 14mm 환봉보강</p>		<p>비육 모돈용/150kg 이상 170mmx200mm</p>	

돼지의 체중별 니플 높이 및 음수량

**설치높이/조건 : 작업환경, 돼지 유형, 사용 목적에 따라 달라질 수 있음





	체중	음수량/일	분당 권장공급량	워터컵의 실제높이 (단위 : cm)	니플의 설치높이 (단위 : cm)
자돈/Piglets	5	0.7	0.5	5-7	15
	10	1.0	0.5	8-12	30-50
	20	2.0	2.0	8-12	30-50
비육/Fattening pig	20-30	3-4	0.5-0.8	15-20	40-55
	30-80	4-8	0.8-1.2	15-20	60-75
	80-100	8-10	0.8-1.2	15-20	65-80
모돈/Sows	Empty and in pig	8-12	1.2-1.8	25-35	90
	Heavy in pig	8-15	1.2-1.8	25-35	90
	Sucking with piglets	15+1.5	2-4	-	90
웅돈/Boars	-	10-15	1.2-1.8	30-40	90

<p>01 아쿠아자동급수기헤드</p>  <p>10mm / 12mm</p>	<p>02 진공밸브</p>  <p>하단형</p>	<p>03 새들</p>  <p>가지새들 농업용새들</p> <p>25 x 13mm / 25 x 15mm</p>	<p>04 급수파이프</p>  <p>15A</p> <p>400/540/850/1000/1200mm</p>
<p>05 호스니플</p>  <p>걸야마 속야마</p> <p>15 x 13mm</p>	<p>06 호스니플 Y자</p>  <p>13mm</p>	<p>07 오메가브라켓</p>  <p>15A/20A/25A</p>	<p>08 급수대 유볼트</p>  <p>급수대블럭</p>
<p>09 스텐엘보</p>  <p>스텐 / 15A / 90° / 45°</p>	<p>10 스텐 정삼티</p>  <p>스텐 / 15A</p>	<p>11 단니플/단소켓</p>  <p>걸야마 속야마</p> <p>스텐 / 15A</p>	<p>12 장니플</p>  <p>스텐 / 15A / 20A</p>
<p>13 스텐밸브</p>  <p>스텐 / 15A / 20A / 25A</p>	<p>14 밸브소켓</p>  <p>15A / 20A / 25A</p>	<p>15 속밸브소켓</p>  <p>15A / 20A / 25A</p>	<p>16 커플링</p>  <p>15A / 20A / 25A</p>

17	이경커플링	18	양엘보	19	이경엘보	20	겉나사티
							
20x15A 25x15A/25x20A		15A/20A/25A		20Ax15A		15x15x15A 20x15x20A/25x15x25A	
21	속나사티	22	정삼티	23	이경티	24	밸브티
							
15x15x15A 20x15x20A/25x15x25A		15x15x15A 20x20x20A/25x25x25A		20x15x20A 25x15x25A/25x20x25A		15x15x15A 20x15x20A/25x15x25A	
25	마감캡	26	니플밸브	27	볼밸브	28	헤드밸브
							
15A/20A/25A		15A/20A/25A		15A/20A/25A		15A/20A/25A	
29	속헤드밸브	30	커플링밸브	31	속나사엘보 1	32	속나사엘보 2
							
15A/20A/25A		15A/20A/25A		15A/20A		15A/CF형	

33	겉나사엘보 1	34	겉나사엘보 2			35	원터치CM	15A/20A	15A/CM형	8/10/12mm	8/10/12mm
37	원터치 엘보	38	원터치삼티			39	원터치와이티	8/10/12mm	8/10/12mm	8/10/12mm	15x10/12mm
41	원터치밸브티	42	호스니플			43	호스니플밸브	15A/20A/25Ax10mm 15A/20A/25Ax12mm	15X13mm	15A x13mm	15A/20A/25Ax10mm 15A/20A/25Ax12mm
45	원터치볼밸브	46	레듀샤			47	우레탄호스	8/10/12mm	20x15mm	8/10/12mm	15/20/25A
45	원터치볼밸브	46	레듀샤			48	PE 파이프	15A/20A/25Ax10mm 15A/20A/25Ax12mm	PE 파이프	PE 파이프	PE 파이프

01	MN-01		42	비육,모돈용/습식/42mm
02	MN-02		67	자돈용/건식/67mm
03	MN-03		72	모돈용/건식/72mm
04	MN-04		73	비육,모돈용/습식/73mm
05	MN-05		90	비육,모돈용/습식/90mm
06	MN-06		82	자돈,비육용/습식/82mm
07	MN-07		74	자돈용(포유)/습식/74mm
08	MN-08		53	자돈,비육용/습식/53mm
09	MN-09		71	자돈용(~35kg)/건식/71mm
10	MN-10		90	비육,모돈용/건식/90mm
11	MN-11		75	자돈,비육용/습식/75mm
12	MN-12		S:52 L:60	비육,모돈용/습식/52,60mm
13	MN-13		79	비육,모돈용/습식/79mm
14	AN-01		68	자돈용/건식/68mm
15	AN-02		80	비육,모돈용/건식/80mm
16	SN-05		79	자돈,비육용/습식/79mm

01	벽면팬 350	02	벽면팬 400	03	벽면팬 500
					
<p>사각팬 / 날개지름 350ϕ 극수 4P 회전수:1,473rpm, 풍량:4,188CMH 소비전력:105W</p>		<p>사각팬 / 날개지름 400ϕ 극수 4P 회전수:1,673rpm, 풍량:7,200CMH 소비전력:290W</p>		<p>사각팬 / 날개지름 500ϕ 극수 4P 회전수:1,637rpm, 풍량:8,340CMH 소비전력:440W</p>	
04	벽면팬 630	05	벽면팬 1000	06	멀티팬(수입)
					
<p>사각팬 / 날개지름 630ϕ 극수 6P 회전수:1,100rpm, 풍량:11,700CMH 소비전력:600W</p>		<p>사각팬 / 날개지름 1,000ϕ 극수 8P 회전수:700rpm, 풍량:24,850CMH 소비전력:756W</p>		<p>사각팬 / 날개지름 500ϕ 풍량:8,240m³/h 소비전력460W</p>	
07	릴레이팬 800	08	릴레이팬 1000	09	릴레이팬 1000
					
<p>중계팬 겸용 / 날개지름 800ϕ 극수 8P 회전수:757rpm, 풍량:18,080CMH 소비전력:456W</p>		<p>중계팬 겸용 / 날개지름 1,000ϕ 극수 8P 회전수:700rpm, 풍량:24,900CMH 소비전력:660W 무게:33.9kg</p>		<p>거치대형 / 날개지름 1,000ϕ 극수 8P 회전수:700rpm, 풍량:24,900CMH 소비전력:660W</p>	

10	순환헨(에어믹스)	11	12
			
<p>FRP갓 / 하단모터 290W / 1,673rpm / 4P</p>		<p>사이즈 : 200D / 250D / 300D</p>	
12-1		13	14
<p>굴뚝헨 세트</p>  <p>샷갓 나팔 연결대 중간셔터통 하단팬</p>		<p>원통셔터</p> 	
<p>5000 / 6300</p>		<p>지름 5000</p>	
15		16	
<p>정압방지후드</p> 		<p>환기박스/입기박스</p>  <p>1,152 408 310</p>	
<p>3500/4000/5000/6300 /8000/1,0000</p>		<p>408mm(W) x 1,152mm(L) x 310mm(H)</p>	

<p>17 유로엠 대형휨 36"</p>	<p>18 유로엠 대형휨 50"</p>	<p>19 유로엠 대형휨 53"</p>
<p>Munters 스웨덴</p> 	<p>Munters 스웨덴</p> 	<p>TERMOTECHNICA PERICOLI 이탈리아</p> 
<p>삼상/날개지름:910Ø/중량 62kg 사이즈:1,091x1,091mm/두께:450mm 0.75HP/환기량:13,100CFM/아연도금</p>	<p>단상,삼상/날개지름:1,220Ø/중량 105kg 사이즈:1,380x1,380mm/두께:450mm 1.5HP/환기량:24,000CFM/아연도금</p>	<p>단상,삼상/날개지름 1,346Ø/중량 80kg 사이즈:1,380x1,380mm/두께:400mm 1.5HP/환기량:24,100CFM / ALL SUS</p>
<p>20 플라스틱 셔터</p>	<p>21 프로젝트창</p>	<p>22 루바창</p>
		
<p>350용:440x402/500용:585x547 600용:633x595/630용:715x677 730용:797x759/주문제작 가능</p>	<p>1,000x400mm/1,000x500mm 주문제작 가능</p>	<p>주문제작</p>
<p>23 무동력입기창(신형/중형)</p>	<p>24 무동력입기창(신형/대형)</p>	<p>25 입기창(에어인넷)</p>
		
<p>타공사이즈 : 690x180mm 입기사이즈 : 575x210mm</p>	<p>타공사이즈 : 1,070x280mm 입기사이즈 : 990x250mm</p>	<p>사이즈 : 1,160x330mm</p>

26	천정입기창 2면	27	천정입기창 4면	28	웬컨트롤러
				<p>3K/PMC-102</p> 	
<p>사이즈 : 320x687x185mm</p>		<p>사이즈 : 687x687x185mm</p>		<p>자동, 수동조절 기능/현재온도, 설정온도 동시 표시 설치용량 : 5000 기준 3대용 허용전류 : 220V 60Hz 10A이하</p>	
29	웬컨트롤러	30	웬컨트롤러	31	웬컨트롤러
<p>6K/PMC-202</p> 		<p>12K/PMC-303</p> 		<p>10K/PMC-100</p> 	
<p>2개출력 개별설정 / 현재온도, 설정온도 동시 표시 설치용량 : 5000 기준 6대용 허용전류 : 220V 60Hz 20A이하</p>		<p>자동, 수동조절 기능 / 3개출력 개별설정 설치용량 : 5000 기준 9대용 허용전류 : 220V 60Hz 30A이하</p>		<p>1개출력 설정 / 현재온도, 설정온도 동시 표시 설치용량 : 5000 기준 10대용 허용전류 : 220V 60Hz 30A이하</p>	
32	대형웬 컨트롤러	33	대형웬 컨트롤러	34	대형웬 컨트롤러
					
<p>삼상 / 380V 2P 유로옴 x 2대</p>		<p>삼상 / 380V 4P 유로옴 x 4대</p>		<p>삼상 / 380V / 5P 유로옴 x 5대 대용량 주문제작 가능</p>	

01

쿨링패드

물흐림 순환방식 쿨링패드

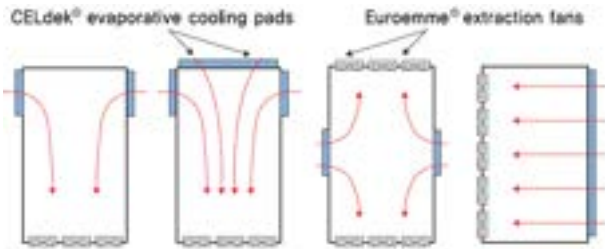

단위:mm

두께	높이	길이(폭)
100/150	2,000	600
100/150	1,500	600
100/150	1,200	600

물흐림 순환방식 쿨링패드 - 내·외부 온도편차 4~5°C



02

UV폴리프로필렌 쿨링패드

주문 제작 가능



- MIK(1.5m³/mh) 타사(1.5m³/mh)
- MIK(0.75m³/mh)

	MIK쿨링패드(mm)
높이(Max)	2,700
폭(Max)	600
두께(T)	150

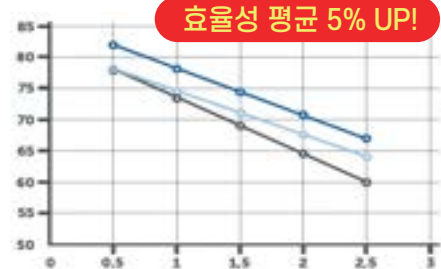

직사광선으로 인한 변형 없음 / 장기간 사용가능(플라스틱) / 손쉬운 세척으로 관리 용이 / 주문제작 가능 / 습기 Free

01

전기보온패드

기존 분만사에도 간편한 설치

1,200
400

1,200x400mm/평균소비전력 75W
1,200x500mm/최대소비전력 120W

전면 열선 코팅으로 완벽한 방수 / 우수한 에너지 효율(75W) / KC 인증획득

02

투명 보온커버

보온 성능 최적화로 사육환경 안정화

KUNLONG
INTERNATIONAL CO.,LTD.

투명커버로 내부확인이 쉽고 작업자의 관리 편의성 증대 / 견고한 재질 사용 / 내부 온도 유지로 돈사 번식환경 개선

01	히팅판넬	02	히팅패드 컨트롤러	03	보온전기매트
					
<p>120x1M/AT / 부식없는 코팅공법 소재 전열기구로부터 화재 위험 해방 열발산이 가장 우수한 알루미늄 방열판</p>		<p>MC-100 / 1kw / 8대 MC-A100 / 3kw / 20대</p>		<p>80W : 400x1200mm 60W : 680x660x630mm</p>	
04	보온전기매트(신형)	05	보온전기매트	06	할로겐 보온갓 육추기
 <p>※2026신형</p>					
<p>L:1,200mmxW:500mm 전력량 : 70W</p>		<p>140W:60x90cm / 220W:60x120,90x90cm 240W:90x120cm / 250W:90x150cm</p>		<p>175W / 250W</p>	
07	할로겐 보온등	08	인터히트 보온갓	09	인터히트 보온갓
		 <p>LP-300 LP-300S</p>		 <p>LPB-300 LPB-300S</p>	
<p>300W / 600W / 900W</p>		<p>LP-300:250W, 220mm LP-300S:250W, 220mm, 3단스위치</p>		<p>LPB-300:375W, 300mm LPB-300S:375W, 300mm, 3단스위치</p>	

<p>10 카본히터 세트</p>  <p>CPBT-300S CFL600 CFL900</p>	<p>11 보온전구</p> 	<p>12 보온등컨트롤러</p> <p>10K/PMC-102H</p> 
<p>카본히터(40cm)+CFL1200(카본램프)</p>	<p>250W / 375W</p>	<p>1CH 출력 / 전선 10 sq 이상 설치용량 : 200W 30대 / 600W 12대</p>
<p>13 모갈</p>  <p>구형 신형</p>	<p>14 할로겐소켓(소)</p>  <p>안쪽형 바깥형</p>	<p>15 할로겐램프</p> 
<p>구형 / 신형</p>	<p>안쪽형 / 바깥형</p>	<p>11.8cm/13.5cm/16.5cm/18,19cm</p>
<p>16 강약조절스위치 고무전선</p>  <p>고무전선 스위치전선</p>	<p>17 원치기계</p> 	<p>18 스텐원치</p> 
<p>하향식 / 상향식(물치포함)</p>	<p>브레이크식 / 수동</p>	
 <p>설치도면 (하향식 원치커튼)</p>		 <p>감을쇠 원치와이어 각종도르레</p>

01

돈형기/출하돈 선별기

50kg 경량 / 내구성 / 사용 편리성

MEIER-BRAKENBERG



마커스틱/스프레이 거치대



LCD 조명 디스플레이



출구 시프트 기능

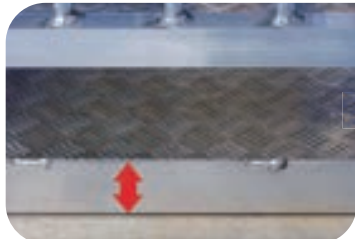

접근 용이(높이 7cm)

580

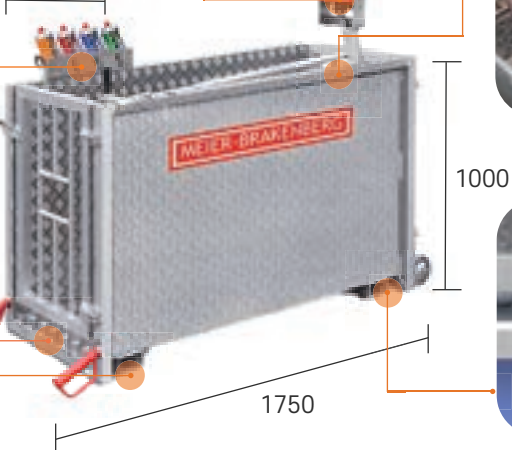

백(BACK) 기능



내구성이 우수한 로드셀

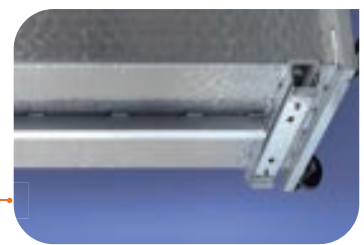

견고한 알루미늄 구조



- 알루미늄 구조로 견고하며 가벼움(50kg) • 이동에 최적화 된 만족스러운 기동성 • 24시간 충전으로 최장 12시간 사용
- 양방향 출구로 편의성 업그레이드(특허) • 조명식 LCD 디스플레이로 쉽게 체중 확인 • 신뢰할 수 있는 20년 전통 브랜드

02

돈형기 / 자돈·육성용

움직임 감지에 최적화된 프로그램

MEIER-BRAKENBERG



• 미끄럼방지 처리된 알루미늄 바닥



• 높이 2cm로 쉬운 접근성





- 부식방지 알루미늄 바닥재
- 미끄럼 방지 처리된 바닥으로 수세 간편
- 단 높이 2cm로 돼지 스트레스 없이 계측
- 조명식 LCD 디스플레이로 쉽게 체중 확인, 구간별 식별 가능
- USB를 통한 개체별 체중 저장(USB포트)
- 풋페달로 원격 잠금 해제

01

사체운반기(전동식)

자돈부터 모돈까지 폭넓은 사용가능

MEIER-BRAKENBERG

300kg까지 이동 가능!



• 초광폭 픽업 롤러로
최대 300kg까지
안전하게 운반가능



1100



• 모터 및 롤러 구동을
위한 직관적인 조작



- 비육용 : 사이즈 560x1130x1100 / 무게 60kg / 모터규격400W 24V DC / 부식방지 처리된 알루미늄 / 충전식 배터리 내장
- 모돈용 : 사이즈 610x1140x1100 / 무게 80kg / 모터규격400W 24V DC / 부식방지 처리된 알루미늄 / 충전식 배터리 내장

02 사체운반기/핸디형(트랜스포커) | 9kg 초경량으로 쉽고 빠른 운반

MEIER-BRAKENBERG



사체운반기(Transporcker)
: 자동용









• 950x345x155mm / 손대지 않고 당김봉 고리를 이용 / 쉽고 빠른 세척 / 견고한 스텐레스 스틸 제작

05 고압세척기(스피디) | 세척기건에 연결하여 간편하게 사용



MEIER-BRAKENBERG



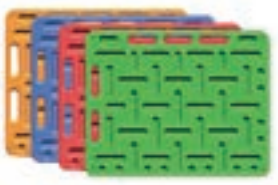

• 레바를 조이면 => 폐수를 빨아들임 / 레바를 풀면 => 신선한 물 급수

<p>01 연속주사기</p>  <p>0.3mm/1mm/2mm/5mm</p>	<p>02 가스단미기</p>  <p>단미기날 단미기샐러더</p> <p>가스충전식(대/소)</p>	<p>03 전기단미기</p>  <p>ON/OFF 스위치</p> <p>220V, 150W</p>	<p>04 견치기</p>  <p>견치기 숯들</p> <p>1회 충전으로 15-20회 작업가능</p> <p>5,000~25,000RPM/속도조절기능</p>
<p>05 마커스틱</p>  <p>60g, 파랑/녹색/빨강/검정</p>	<p>06 마커스프레이</p>  <p>400ml, 파랑/빨강/녹색</p>	<p>07 응취스프레이</p>  <p>250ml</p>	<p>08 꼬리물기방지스프레이</p>  <p>500ml</p>
<p>09 온.습도계</p>  <p>디지털 / 최고.저 온도계</p>	<p>10 모돈체온계</p>  <p>디지털 / 135mm</p>	<p>11 압박기(핸즈프리)</p>  <p>PP(폴리프로필렌)</p>	<p>12 코보정기</p>  <p>T-형 / 후크형</p>
<p>13 조산기</p>  <p>2번:42cm 4번:52cm</p>	<p>14 슬러리뚜껑/볼/소켓</p>  <p>200Ø</p>	<p>15 슬러리볼</p>  <p>200Ø / A:7.4kg B:2.4kg C:6kg D:모래 주입</p>	

16	이각기	17	스텐니퍼				
스텐 / A:16cm B:12cm		스텐레스 / 16cm		A:65cm,2.8kg B:41cm,1.9kg		스텐레스 / 21.5cm	
20	펀치기	21	이표 장착기				
알루미늄+스텐 / 19cm		지택 / 26cm		빨강색 / 500ml		38cm / 395g / 0~9번	
24	돼지몰이판	25	발판소독조				
대 / 중 / 소 120x74/93x74/74x45cm		PVC / 44x39x60cm		전장 : 103cm / 무게 : 430g		20kg / 1포	
28	크린매트			29	양돈티슈		
 	420mm x 1,120mm / 35매 / 1박스				갈색 / 400매 / 1박스		

30

대용유 / 자동급이시스템

방역이 힘든 분만사 바이러스 확산으로 인한 자돈의 폐사를 획기적으로 줄여 이유 체중과 생존율 개선!

DanMilk™ 덴마크 수입



대용유 20kg / 1포



환상적인 맛과 향



모유 유사/생존력 향상



자돈 필수영양소제공



사료비용 절감/체중증가

Pump'n'Grow™ Fresh

대용유 자동급이시스템 BAROTECH

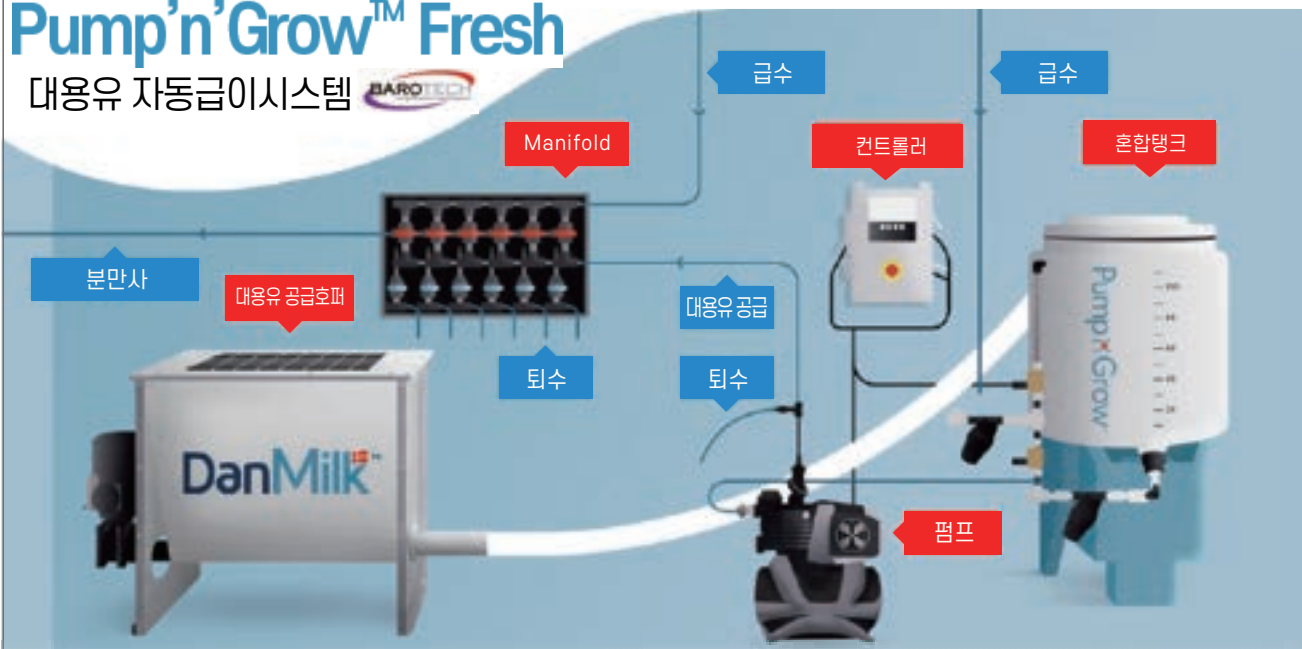

- 30L 단위로 신선한 대용유 공급
- 최소한의 작업으로 간편하게 사용
- 간단한 모듈식으로 손쉬운 유지 관리
- 1개 시스템으로 최대 모돈 4,000두까지 공급
- 대용유 낭비 없이 매일 청소 가능

31 사체운반기



사양 모델	높이 (cm)	폭 (cm)	기장 (cm)	산날넓이 (cm)	무게 (kg)
한 날	190	37	110	26	50

※600kg까지 운반가능

32 거세틀



스탠드식 / 칸막이 거치식

33 자외선살균기



110L / W:500 x D:450 x H:700mm

34 다목적 대인소독기



W:1,200 x D:1,000 x H:2,200mm
170kg / 광산화 탈취기 탑재

35 돈분제거기



빅스타 II

악조건 작업가능 / 소모품외 별도 A/S 불필요
한날 높이:75x폭:37x기장:110x산날넓이:26cm

36 장화세척기



HACCP 필수품

스텐레스/플라스틱브러쉬
W:300 x D:350 x H:900mm

37 고압세척기



K-2160

단상/160bar/2HP/11L/15m/1,700rpm
L:375 x W:600 x H:900mm / 39.5kg

38 고압세척기



CP-275

삼상, 7.5HP, 200bar, 15L/min
삼상, 10HP, 250bar, 15L/min
삼상, 15HP, 300bar, 20L/min

<p>39 세척기 건</p>  <p>삼상 / MV925</p>	<p>40 세척기 건</p>  <p>슈퍼권총 / 37cm</p>	<p>41 세척기 노즐</p>  <p>블랙 / 회전 / 직선노즐</p>	<p>42 랜스대</p>  <p>70/90/120/150cm</p>
<p>43 돈사용 손수레</p>  <p>B1 B2 올스텐</p> <p>B1:90x68cm B2:96.5x57cm</p>	<p>44 스모그스틱</p>  <p>10 PCS</p>	<p>45 비닐장화</p>  <p>38cmx53cm 팩/5묶음(50장)</p>	<p>46 방역복</p>  <p>원피스형, XXL, box/24EA</p>
<p>47 사료배합기</p>  <p>단상/2마력/8포/최대 200kg 시간:약 8분/높이:2.2M</p>	<p>48 사료배합기</p>  <p>75kg 125kg</p> <p>단상/2마력/3포/75kg 삼상/3마력/5포/125kg</p>	<p>49 스텐 방화도어</p>  <p>외부 내부 깃대경첩</p> <p>판넬형 / 조적형 / 주문제작 가능</p>	

독점공급





회 사 명

MIK International
(1968년 설립)

본사주소

Masselbachstr.22, DE-56235
Ransbach Baumbach Germany

회사소개

MIK International은 BMW, 포르세자동차의 헤드라이트 및 독일 밀레청소기 하우징을 제조하는 Josef Mawich의 자회사로서 플라스틱 바닥재 **세계 1위** 업체입니다.



생산라인 전경

주요품목

플라스틱 바닥재, 델타빔(GRP), 칸막이, 급이기, 자동라인설비, 보온 바닥재 등

제품특징

모회사가 자동차 부품업체이기 때문에 품질 기준이 엄격하며 자동차 품질기준 TS16949를 보유하고 있습니다. 또한 플라스틱 바닥재의 경우 100,000번의 테스트 후 출고되어 엄선된 최고의 품질을 자랑합니다.





회 사 명

Rotecna S.A.
(1991년 설립)

본사주소

Pol. Ind. s/n, n3 25310 Agramunt (Lleida) SPAIN

회사소개

Rotecna S.A.는 양돈 토탈 솔루션 공급업체로 전제품을 자가 생산 및 공급하고 있습니다.
판매의 70%를 80개국으로 수출, 별도의 R&D팀이 있어 기존 제품 테스트 및 신제품 개발하여 양돈가의 생산성 향상을 위해 노력하고 있습니다.

주요품목

포유 모돈 급이기, 각종 급이기, 플라스틱 베드, 보온패드 커버, 칸막이, 자동급이라인, 슬러리 처리기 등

제품특징

Non stop 솔루션으로 양돈의 주요제품을 직접 생산 공급하여, 각각의 제품이 서로 연계되어 있습니다.





회 사 명

Falcon S.r.l
(1972년 설립)

본사주소

Via per Airuno 29, 23883 Brivio Italy

회사소개

1975년 체인식 급이시스템을 세계 최초로 개발 공급 하였으며 현재는 60Ø~ 102Ø로 다양한 자동 급이시스템을 공급하고 있습니다.

주요품목

양돈, 양계, 축우용 자동급이시스템

제품특징

자동급이라인의 원조회사로 제품의 내구성 및 안전성을 바탕으로 장기간 사용이 가능합니다.

특히, 질병 방역이 중시되는 현 상황에서 벌크빈 사료 이송에 매우 효과적인 솔루션을 제공합니다.



MEIER-BRAKENBERG



회 사 명

Meier-Brakenberg
(1998년 설립)

본사 주소

Brakenberg 29, 32699 Exteral Germany

회사소개

Meier-Brakenberg는 안개분무시스템 공급을 시작으로 회사가 설립 되었습니다.

특이한 점은 Meier가 비육돈 4,000두를 사육하는 농장과 본사가 함께 있어, 실질적으로 제품을 농장에서 테스트 한 후 개발 공급한다는 것입니다.

주요품목

돈형기, 사체운반기, 고압세척기, 소독기, 안개분무 및 쿨링 시스템

제품특징

돈형기의 경우 제품보증 기간이 길고 품질이 우수하며, 농가맞춤 제품으로 농가에서 사용하기 편리합니다.



회 사 명

Monoflo
(1962년 설립)

본사 주소

Vogelsbergstr. 6 D-64646 Heppenheim,
Germany

회사소개

지난 55년간 가업으로 급수시스템을 필두로 하여
급이기, 보온패드, 급수필터, 양계 급이 급수기를
공급하고 있습니다.

주요품목

Total 급수 시스템, 양돈 급이기, 양계 급이 급수기,
보온패드

제품특징

주요품목인 급수시스템(니플포함)에 특화되어
있으며, 부속자재가 세밀하게 구성되어 있습니다.



NOOYEN ▲ PIG FLOORING



회 사 명

Nooyen Group
(1978년 설립)

본사주소 Haageind 60 5754 BZ Deurne
Netherlands

회사소개

Nooyen Group은 1978년 창립자 Grard Nooyen이 6명의 아들과 함께 회사를 설립했으며, 현재는 Grard의 손자인 Gerben이 회사를 운영중입니다. Nooyen 바닥재의 특징은 부드럽고 연성이 좋은 플라스틱질의 재료로 코팅처리하여 바닥재의 명품이란 명성을 얻게 되었습니다. 더욱이 난연 인증 BFS-S1 획득하여 화재에 강하고 안전한 제품을 공급하고 있습니다.

주요품목

분만사 바닥재, 자돈 비육사 바닥재 등 주문제작 바닥재

제품특징

동물복지형 바닥재로 뛰어난 위생, 자돈 스트레스 감소, 반영구적 사용이 가능합니다.

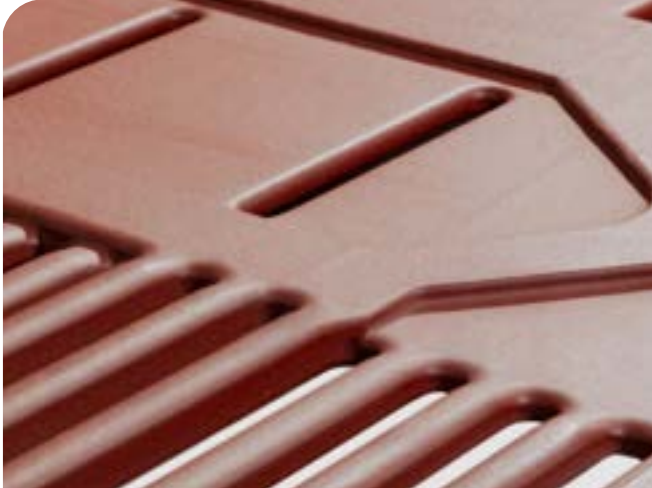

회 사 명

Schonlau
(1904년 설립)

본사주소

Ernst-von-Bayern-Straße 22, 59590
Geseke, GERMANY

회사소개

120년 전통 주철베드의 원조! 연간 12,500톤의 철을 공급하며 철 주조에 특화된 전문업체로 각종 주철과 몰딩, 특수합금 제품 제작에 탁월합니다.

주요품목

주철베드, 펌프, 콤프레셔, 화학 기계 및 부속품

제품특징

모래금형을 통해 제작되며, 이동 중 제품 손상을 막기위한 특수코팅 및 주철베드 각 부분이 라운드형으로 유두보호 및 탈골, 미끄럼방지, 청결성 등 모든이 활동하기 좋은 최적의 환경을 제공합니다.



miXtron



회 사 명

Mixtron S.r.l.
(2017년 설립)

본사주소

Via delle Nazioni,
Emilia-Romagna, Italy

회사소개

Mixtron S.r.l.는 이탈리아 에밀리아-로마냐 지역에 본사를 둔 비례식 정량 주입 펌프 및 고압 펌프 전문 제조 기업입니다. 설립 이후 정밀 유체 제어 기술을 기반으로 산업, 축산 및 농업 분야에 적용 되는 고품질 정량 주입 솔루션을 설계·개발·생산 하고 있습니다.

주요품목

음수투약기, 고압 펌프, 산업용 유체 주입 시스템

제품특징

이탈리아 현지에서 직접 설계하고 제조하며, 엄격한 품질 관리 시스템을 통해 완성도를 높였습니다. 다양한 산업 현장에 적용할 수 있는 뛰어난 내구성과 안정적인 성능으로 신뢰를 제공합니다.



회 사 명

Kunlong International Co., Ltd.(2002년 설립)

본사주소

Qingdao, Shandong Province, China

회사소개

중국 칭다오에 위치한 축산·농업 기자재 전문 제조 기업으로, 20년 이상의 축적된 제조 경험을 바탕으로 축사 환경 개선과 생산성 향상을 위한 다양한 축산 설비와 부품을 연구·개발·생산하고 있으며, 현재 세계 80여 개국에 OEM 방식으로 제품을 생산·수출하고 있습니다.

주요품목

축산용 보온·단열 기자재 및 축산관련 장비제작

제품특징

축사 환경에 적합한 내구성과 실용성을 갖춘 제품 생산, 글로벌 수출 기준에 부합하는 체계적인 품질 관리시스템을 운영중입니다. 합리적인 가격 경쟁력을 바탕으로 품질과 비용 효율성을 동시에 제공합니다.



**합리적 비용
 앞선 기술력
 완벽한 시공**

현장의 작은 변화가 생산성의 차이를 만듭니다.

바로텍은
축산 환경의 본질을 이해하는 것에서 시작합니다.

단순한 설비 공급을 넘어,
돼지와 사람이 함께하는 공간의 가치를 고민합니다.

온도와 습도, 물의 흐름까지-
보이지 않는 환경 요소들은 생산성과 직결됩니다.

바로텍은 이러한 미세한 차이를 정밀하게 제어하기 위해
현장 중심의 설계와 기술 개발을 이어오고 있습니다.

오랜 경험과 축적된 기술력을 바탕으로
내구성과 실용성을 갖춘 기자재를 개발하며,
현장에서 검증된 안정적인 성능을 제공합니다.

또한, 체계적인 품질 관리와 지속 가능한 설계를 통해
고객의 신뢰에 보답하고 있습니다.

더 나은 환경, 더 나은 미래!

바로텍은 오늘도 보이지 않는 곳에서
농장의 생산성과 효율을 높이는데 집중합니다.



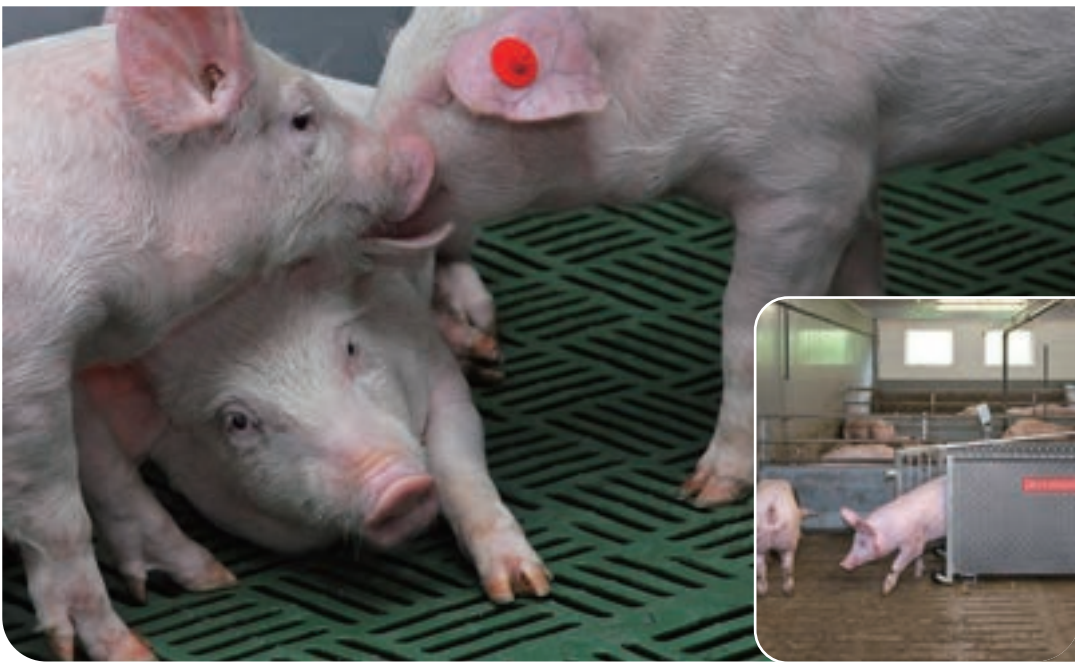

홈페이지 방문



카카오톡 상담

양돈인을 위한 현명한 선택 —

BAROTECH (주)바로텍

충남 천안시 동남구 병천면 충절로 1902(탑원리 86-5)
 전화 (041)522-1817~9 팩스 (041)522-1816
 이메일 barotech22@daum.net / 010.8644.1817